

XVS400 10.4"/12.1"/15" MICRO PANEL



Powering Business Worldwide

Manufacturer

Eaton Automation AG
Spinnereistrasse 8-14
CH-9008 St. Gallen
Switzerland
www.eaton-automation.com/en
www.eaton.com

Support**Region North America**

Eaton Corporation
Electrical Sector
1111 Superior Ave.
Cleveland, OH 44114
United States
877-ETN-CARE (877-386-2273)
www.eaton.com

Other regions

Please contact your local supplier or send an Email
to: automation@eaton.com

Original instructions

The German version of this document is the original instructions.

Translations of the original instructions

All non-German editions of this document are translations of the original instructions.

Editor

Monika Jahn

Brand and product names

All brand and product names are trademarks or registered trademarks of the owner concerned.

Copyright

© Eaton Automation AG, CH-9008 St. Gallen

All rights reserved, also for the translation.

None of this document may be reproduced or processed, duplicated or distributed by electronic systems in any form (print, photocopy, microfilm or any other process) without the written permission of Eaton Automation AG, St. Gallen.

Subject to modifications.

Contents

1	General	5
1.1	Purpose of these Operating Instructions.....	5
1.2	Comments about this document.....	5
1.3	Additional documentation.....	5
2	Device description	7
2.1	Device names.....	7
2.2	Function.....	7
2.3	Intended use.....	7
2.4	Device versions.....	7
2.5	Package contents.....	8
2.5.1	Package contents for devices with resistive touch.....	8
2.5.2	Package contents for devices with infra-red touch.....	9
2.6	Accessories.....	9
2.7	Designation.....	10
3	Safety regulations	11
3.1	General.....	11
3.2	Meaning of symbols.....	12
3.3	Mandatory requirements, personnel.....	13
3.3.1	Work safety.....	13
3.3.2	Qualification of personnel.....	13
3.3.3	Operating Instructions.....	13
3.3.4	Installation, maintenance and disposal.....	13
3.3.5	Prohibited use.....	13
3.3.6	Requirements for proper operation.....	14
3.4	Device related hazards.....	15
4	Operating and indication elements	19
4.1	Operating and indication elements on the front.....	19
4.2	Operating elements on the service side.....	20
4.3	Indication elements on the service side.....	21
5	Installation	23
5.1	Safety regulations.....	23
5.2	Requirements for the place of installation.....	24
5.2.1	Engineering conditions of acceptability by Underwriters Laboratories Inc. (UL).....	24
5.2.2	Requirements for the mounting position.....	24
5.3	Interfaces.....	25
5.3.1	Overview of interfaces.....	26
5.3.2	Preparation of cables with D-Sub connector.....	27
5.3.3	Power supply.....	29
5.3.4	RS232 (System Port).....	30
5.3.5	Ethernet.....	32
5.3.6	USB Device.....	33
5.3.7	USB Host.....	33

Contents

5.3.8	Profibus	34
5.4	Mounting	36
5.4.1	Mounting the device	37
6	Operation	43
6.1	Safety regulations	43
6.2	Starting the device	44
6.3	Switching off the device	46
7	Maintenance and service	47
7.1	Safety regulations	47
7.2	Maintenance	48
7.2.1	Cleaning the resistive touch	48
7.2.2	Recalibrating a resistive touch	48
7.2.3	Cleaning the infra-red touch	49
7.2.4	Recalibrating the infra-red touch	49
7.2.5	Battery	49
7.3	Service	50
7.3.1	Repairs	50
7.4	Troubleshooting	51
8	Storage, transport and disposal	53
8.1	Safety regulations	53
8.2	Storage	53
8.3	Transport	53
8.4	Disposal	54
9	Technical data	55
9.1	Dimensions and weights	55
9.1.1	10.4" devices	55
9.1.2	12.1" devices	56
9.1.3	15" devices	57
9.2	Display	58
9.3	Touch sensor	59
9.3.1	Devices with resistive touch	59
9.3.2	Devices with infra-red touch	59
9.4	System	59
9.5	Interfaces	60
9.5.1	Power supply	60
9.6	Enclosure ratings	61
9.7	Agency approvals and standards	61
9.8	Applicable standards and regulations	62
9.9	Ambient conditions	63

1

General

1.1

Purpose of these Operating Instructions

These Operating Instructions contain the information required for the correct and safe use of the MICRO PANELs XVS400 10.4"/12.1"/15"; MS2 10.4"/12.1". The Operating Instructions are part of the devices and must therefore be kept nearby.

These Operating Instructions describe all aspects of the devices: transport, installation, commissioning, operation, maintenance, storage and disposal. The operating system and the application software are not described.



Read Chapter 3 Safety regulations, 11 before working with the device. This contains important information for your personal safety. This chapter must be read and understood by all persons working with this device.

WARNING



Incomplete copy of the Operating Instructions

Working with individual pages of these Operating Instructions may cause damage to property or personnel by failure to observe safety-related information.

▶ Always work with the complete document.

1.2

Comments about this document

Please send any comments, recommendations or suggestions relating to this document to info-automation@eaton.com.

1.3

Additional documentation

The following documents may be helpful in the use of the device in addition to this document. These can be downloaded from our home page (www.eaton-automation.com/en), «DOWNLOADS» section.

- [1] MN05010007Z-EN System Description Windows CE
(operation of the Windows CE operating system on MICRO PANELs)
- [2] MN05010009Z-EN System Description Networks in Brief
(information on networks in general and on the integration of PCs and MICRO PANELs in networks)

1 General

1.3 Additional documentation

2 Device description

2.1 Device names

XVS400 10.4"/12.1"/15" and MS2 10.4"/12.1" are two different names of equivalent products.

2.2 Function

MICRO PANELs XVS400 10.4"/12.1"/15"; MS2 10.4"/12.1" can be used as HMI devices or as integrated HMI/PLC devices.

2.3 Intended use

MICRO PANELs XVS400 10.4"/12.1"/15"; MS2 10.4"/12.1" are primarily used in machine and system building. They are designed exclusively for the visualization, operation and control of machines and systems. Any other use must be agreed beforehand with the manufacturer.

2.4 Device versions

MICRO PANELs XVS400 10.4"/12.1"/15"; MS2 10.4"/12.1" are available in the following versions:

Version with	XVS400 type	MS2 type
Resistive touch 10.4"	XVS-430-10MPI	MS2-430-10MPI
Infra-red touch 10.4"	XVS-440-10MPI	MS2-440-10MPI
Resistive touch 12.1"	XVS-430-12MPI	MS2-430-12MPI
Infra-red touch 12.1"	XVS-440-12MPI	MS2-440-12MPI
Infra-red touch 15"	XVS-460-15MPI	

Tab. 1 Device versions



Fig. 1 XVS400, MS2 with resistive touch



Fig. 2 XVS400, MS2 with infra-red touch

2 Device description

2.5 Package contents

2.5

Package contents

The accessories supplied with the MICRO PANELs XVS400 10.4"/12.1"/15"; MS2 10.4"/12.1" depend on the device version.

2.5.1

Package contents for devices with resistive touch

Qty	Designation
1	MICRO PANEL: ■ XVS-430-10MPI or ■ MS2-430-10MPI ■ XVS-430-12MPI ■ MS2-430-12MPI
6	Retaining brackets with threaded pin for mounting the device
1	Sealing strip for mounting the device
1	Power supply connector
1	CF slot cover (fitted)
1	Stylus

Tab. 2 Package contents for devices with resistive touch

2.5.2

Package contents for devices with infra-red touch

10.4" and 12.1" devices

Qty	Designation
1	MICRO PANEL: <ul style="list-style-type: none"> ■ XVS-440-10MPI or ■ XVS-440-12MPI
	<ul style="list-style-type: none"> ■ MS2-440-10MPI or ■ MS2-440-12MPI
6	Retaining brackets with threaded pin for mounting the device
1	Sealing strip for mounting the device
1	Power supply connector
1	CF slot cover (fitted)

Tab. 3 Package contents for 10.4" and 12.1" devices with infra-red touch

15" devices

Qty	Designation
1	MICRO PANEL: <ul style="list-style-type: none"> ■ XVS-460-15MPI
8	Retaining brackets with threaded pin for mounting the device
1	Sealing strip for mounting the device
1	Power supply connector
1	CF slot cover (fitted)

Tab. 4 Package contents for 15" devices

2.6

Accessories

Different accessories are available. Use only original accessories.



Order the accessories required from your supplier. Required accessories for:

- **Mounting with increased protection class:**
See Chapter 9.6 Enclosure ratings, 61.
- **Use in a potentially explosive atmosphere:**
See Chapter 9.7 Agency approvals and standards, 61.

2 Device description

2.7 Designation

2.7

Designation

Nameplate

A nameplate is fixed on the rear of the device in order to identify it. The nameplate contains the following information:

- Manufacturer address
- Type designation
- Power supply required
- Part no. (Part-No or Art.-No)
- Serial no.
- Time of manufacturing (week/year)
- Approval mark and information to the approval
- Arrangement of interfaces and operating elements

Support

To ensure fast and optimum support always provide the support personnel with the following information on the nameplate:

- Part no. (Part-No or Art.-No)
- Serial no.

3 Safety regulations

3.1 General

Hazards may still occur even though the device meets the current state of the art and complies with all recognized safety requirements.

The device must only be installed and commissioned in perfect technical condition and in compliance with this document.











Read this chapter before working with the device. This contains important information for your personal safety. This chapter must be read and understood by all persons working with this device.

3 Safety regulations
3.2 Meaning of symbols

3.2

Meaning of symbols

The following symbols are used in this document according to the hazard level described:

 DANGER	
	Signal word DANGER Indicates an imminently hazardous situation which, if not avoided, will result in death or serious injury.
 WARNING	
	Signal word WARNING Indicates a potentially hazardous situation which, if not avoided, could result in death or serious injury.
 CAUTION	
	Signal word CAUTION Indicates a potentially hazardous situation which, if not avoided, could result in minor or moderate injury.
 CAUTION	
	Signal word CAUTION without safety alert symbol Indicates a situation which, if not avoided, could result in material damage.

 **Indicates useful information.**

The danger symbol used and the text indicate the actual danger and the related preventative measures.

3.3 Mandatory requirements, personnel

3.3.1 Work safety



All applicable work safety regulations (in-house and national) must be observed.

3.3.2 Qualification of personnel

The personnel responsible for installation, operation, maintenance and service must be adequately qualified. These persons must be sufficiently trained or instructed and they must be informed of all hazards and risks associated with the device.

3.3.3 Operating Instructions

It must be ensured that any person working with the device in any phase of its lifespan has read and understood the relevant sections of the Operating Instructions.

 WARNING	
	<p>Incomplete copy of the Operating Instructions</p> <p>Working with individual pages of these Operating Instructions may cause damage to property or personnel by failure to observe safety-related information.</p> <p>▶ Always work with the complete document.</p>

3.3.4 Installation, maintenance and disposal

It must be ensured that the device is properly connected, mounted, maintained and disposed of in compliance with all relevant standards and safety regulations.

3.3.5 Prohibited use

The implementation of safety functions (relating to the protection of personnel and machinery) using the device is prohibited.

3 Safety regulations

3.3 Mandatory requirements, personnel

3.3.6

Requirements for proper operation

The following points must be observed so that the device meets the contractual requirements:

- Only qualified personnel may work with the device.
- These persons must have read the Operating Instructions and must observe the requirements described.
- The ambient conditions stated must be observed. See Chapter 9.9 Ambient conditions, 63.
- The maintenance work must be carried out correctly.

No liability is accepted for damage, consequential damage and accidents caused by the following:





- Failure to observe work safety regulations
- Failure or malfunction of the device
- Improper handling or use
- Failure to observe the Operating Instructions
- Conversions, modifications and repairs to the device



Repairs, see Chapter 7.3.1 Repairs, 50.

3.4

Device related hazards

⚠ DANGER	
	<p>Explosion hazard</p> <p>Death, serious injury or material damage may occur if an electrical plug connection is removed in a potentially explosive atmosphere during operation or if the device is subjected to hazardous knocks.</p> <ul style="list-style-type: none">▶ Only use the device in the following environments:<ul style="list-style-type: none">- Environments not subject to explosion hazards- Potentially explosive atmosphere, Zone 22 (according to ATEX 94/9/EC)▶ Prevent the device from being subjected to hazardous knocks.▶ Only operate the device in potentially explosive atmospheres if it is correctly mounted.▶ Switch off the device before removing the plug connections.
⚠ WARNING	
	<p>Live parts in the device</p> <p>When the device is opened, there is a risk of electric shock if live parts are touched.</p> <ul style="list-style-type: none">▶ The device must not be opened.
⚠ WARNING	
	<p>Potential equalization currents</p> <p>Large equalization currents between the protective ground systems of different devices may cause operational malfunctions due to signal interference and may even cause fires.</p> <ul style="list-style-type: none">▶ If necessary, a potential equalization conductor should be installed parallel to the cable. This should have a cross-section that is a multiple of the cable shield.
⚠ CAUTION	
	<p>Electrostatic discharge</p> <p>Electrostatic discharge may damage or destroy electronic components.</p> <ul style="list-style-type: none">▶ Avoid contact with components (such as connector pins) that are susceptible to electrostatic discharge.▶ Discharge (by touching a grounded metal object) any static charge accumulated in your body before touching the device.

3 Safety regulations

3.4 Device related hazards

CAUTION



Non-isolated interfaces

The device may be damaged due to potential differences.

- ▶ The GND terminals of all bus stations must be connected.

CAUTION



Sensitive resistive touch surface

Damage to the resistive touch due to the use of pointed or sharp objects.

- ▶ Only activate the resistive touch with your finger or a stylus.
- ▶ When wearing gloves, ensure that these are clean. They must not be covered with abrasive dust or sharp particles.

CAUTION



Data loss

During a write operation, the CF card may lose data or may be destroyed if it is removed or if there is a power failure.

- ▶ Always secure CF cards with the CF slot cover.
- ▶ Avoid write operations to CF cards. Reasons:
 - The number of write cycles possible on CF cards is limited.
 - A power failure during write operations will most likely lead to loss of data.
- ▶ Before removing the CF card in CF slot 1, ensure that no software write operations to the CF card are in progress («CF ACT» LED must not be lit).
- ▶ Only remove the CF card from CF slot 0 when the device is in a de-energized state.
- ▶ Before switching off, ensure that no software write operations to the CF card are in progress («CF ACT» LED must not be lit).

CAUTION



Device condensation

If the device is or was exposed to climatic changes (temperature fluctuation, air humidity) moisture can form on or in the device (device condensation). In this case, there is a risk of short-circuit.

- ▶ The device must **not** be switched on when device condensation is present.
- ▶ If condensation is present on the device, or if it was exposed to temperature fluctuations, it must be allowed to adjust to room temperature (do not expose the device to the direct heat of heating devices) prior to commissioning.

CAUTION



UV light

When exposed to UV light, plastics can embrittle and the lifespan of the device is reduced.

- ▶ Protect the device against direct sunlight (UV rays).

CAUTION



Cleaning the device

Damage to the device due to the use of pointed or sharp objects or by liquids.

- ▶ Do not use any pointed or sharp objects (e.g. knife) for cleaning.
- ▶ Do not use any aggressive or abrasive cleaning agent or solvent.
- ▶ Avoid any liquid entering the device (risk of short-circuit).

3 Safety regulations

3.4 Device related hazards

4 Operating and indication elements

4.1 Operating and indication elements on the front

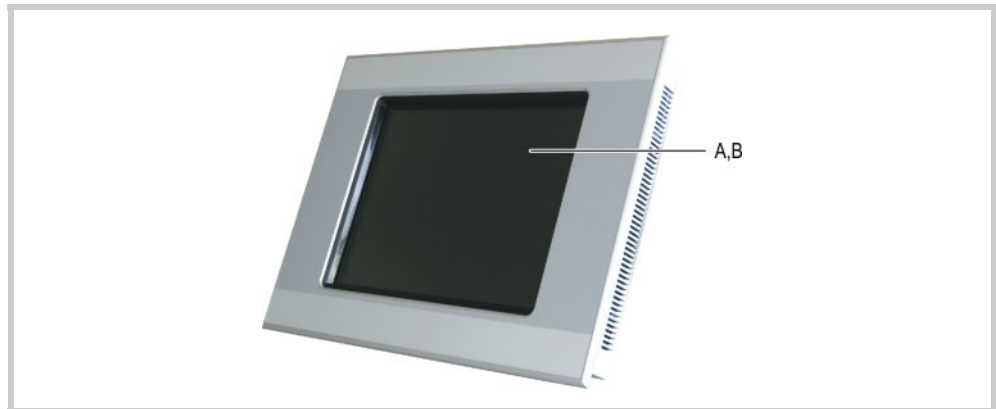

Fig. 3 Operating and indication elements on the front (figure shows device with infra-red touch)

The device has the following operating and indication elements on the front:

Element	Function
A Touch sensor	Detection of the actuation of the operating elements shown on the display. <ul style="list-style-type: none"> ■ Resistive touch: These devices are operated by touching the operating elements with your finger or with a stylus. ■ Infra-red touch: These devices are operated by interrupting the infra-red light matrix with your finger or a suitable object (min. \varnothing 7 mm). It is not necessary to touch the infra-red touch protective panel.
B Display	Display operating and indication elements.

Tab. 5 Operating and indication elements on the front

4 Operating and indication elements
 4.2 Operating elements on the service side

4.2 Operating elements on the service side



Fig. 4 Operating elements on the service side (CF slot cover fitted)

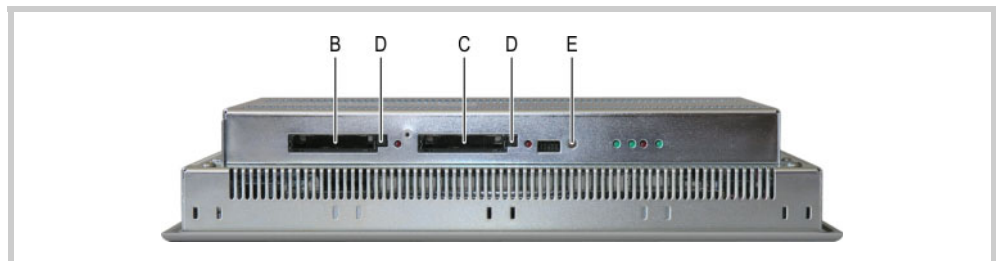

Fig. 5 Operating elements on the service side (CF slot cover removed)

The device has the following operating elements on the service side:

Element	Function
A CF slot cover	Fastening the CF card in the CF slot.
B CF slot 1	Slot for CF card with data.
C CF slot 0	Slot for CF card with operating system and normally with PLC and visualization projects.
D Ejector button	Ejecting the CF card.
E Control button	Function depends on the software used.

Tab. 6 Operating elements on the service side

4.3

Indication elements on the service side

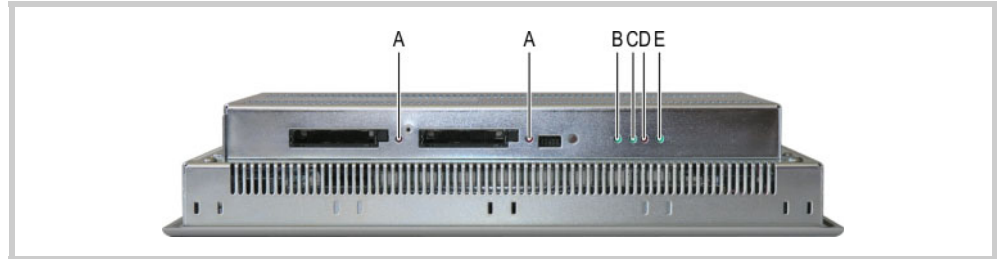

Fig. 6 Indication elements on the service side

The device has the following indication elements on the service side:

LED	Function
A CF ACT (red)	Lit if the CF card is accessed.
B PROFIBUS ACT (green)	Lit if data is transferred via the Profibus interface.
C TOUCH ACT (green)	<ul style="list-style-type: none"> ■ Dark during boot up. ■ Lit when the touch sensor is ready. ■ Flashes when actuating the touch sensor.
D TOUCH ERROR (red)	<ul style="list-style-type: none"> ■ Lit during boot up. ■ Dark when the touch sensor is ready. ■ Lit in the event of errors. ■ Flashes if the infra-red frame is contaminated and has to be cleaned (cleaning the infra-red touch, → Chapter 7.2.3, 49). ■ Flashes if the resistive touch is incorrectly calibrated (touch calibration, → Document «MN05010007Z-EN System Description Windows CE»).
E SUPPLY OK (green)	Lit if all internal system voltages are present.

Tab. 7 Indication elements on the service side

4 Operating and indication elements

4.3 Indication elements on the service side

5 Installation

5.1 Safety regulations



Read Chapter 3 Safety regulations, 11 before installing and commissioning the device. This contains important information for your personal safety.

5 Installation

5.2 Requirements for the place of installation

5.2 Requirements for the place of installation

- Approvals:
The device must only be used in locations that are approved for the device. See the markings on the nameplate and Chapter 9 Technical data, 55.
- Power supply:
The power supply must comply with the requirements stated in Chapter 9.5.1 Power supply, 60.

5.2.1 Engineering conditions of acceptability by Underwriters Laboratories Inc. (UL)

The device must be installed in an end-product. For the approval in accordance with the standard UL 60950, consideration must be given to the following:

- The environment of the device must comply with pollution degree 2.
- The device must be supplied via a SELV source.
- The device must be connected to the protective earth of the end-product (the functional earthing connection of the power supply interface must be connected).
- In order to protect the device from potential internet threats, it should be connected to Ethernet networks that are isolated from the internet or safety protected and isolated from the Corporate/Enterprise network by a firewall or router.
- Fire protection and electrical protection must be ensured via the end-product (not required for the front of the device).

5.2.2 Requirements for the mounting position

The device is designed for mounting in control cabinets, control panels or control desks. 10.4" and 12.1" devices can be mounted horizontally or vertically, 15" devices must only be mounted horizontally. The following requirements must be fulfilled when selecting a suitable mounting position:

- The device should not be exposed to direct sunlight (Sunlight disturbs the infra-red touch sensor. In addition, when exposed to UV light, plastic parts of the device can embrittle and the lifespan of the device is reduced).
- If the device is to be used in potentially explosive atmospheres, the device must not be subjected to hazardous knocks.
- The operating elements on the service side of the device and the cable connections are accessible after the device has been mounted.
- The ambient conditions stated must be observed. See Chapter 9.9 Ambient conditions, 63.
- Sufficient ventilation (cooling) must be ensured by means of:
 - Clearance of at least 3 cm to the ventilation slots
 - Clearance of at least 15 cm from heat radiating components such as heavily loaded transformers
 - The expected temperatures should be within the permissible range. See Chapter 9.9 Ambient conditions, 63.
- Properties of the mounting surfaces:
 - Material thickness at the mounting cutout 2...5 mm
 - Flatness ≤ 0.5 mm
(this requirement must also be fulfilled when the device is mounted!)
 - Surface roughness $R_z \leq 120$

5.3

Interfaces

WARNING



Potential equalization currents

Large equalization currents between the protective ground systems of different devices may cause operational malfunctions due to signal interference and may even cause fires.

- ▶ If necessary, a potential equalization conductor should be installed parallel to the cable. This should have a cross-section that is a multiple of the cable shield.

CAUTION



Operational malfunctions

Use of unsuitable or improperly prepared cables, as well as incorrect wiring will mean that neither the values stated in the technical data nor the electromagnetic compatibility (EMC) can be ensured.

- ▶ Only use cables prepared by specialists.
- ▶ The cables used must be prepared according to the interface description in this document.
- ▶ The wiring instructions for the relevant interface must be observed when wiring the device.
- ▶ Any generally applicable regulations and standards must be fulfilled.

5 Installation

5.3 Interfaces

5.3.1

Overview of interfaces

Connector side:

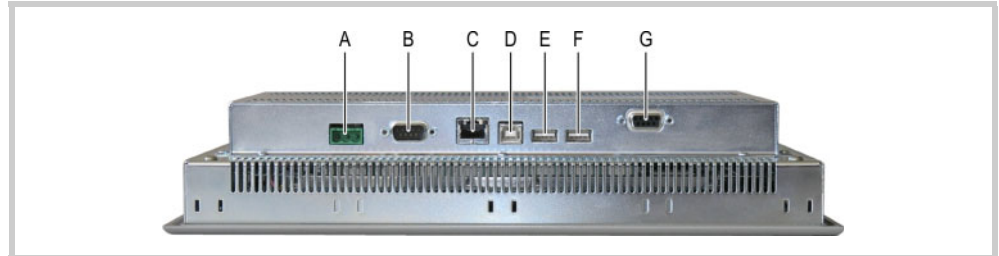

Fig. 7 Connector side of the device

Service side:

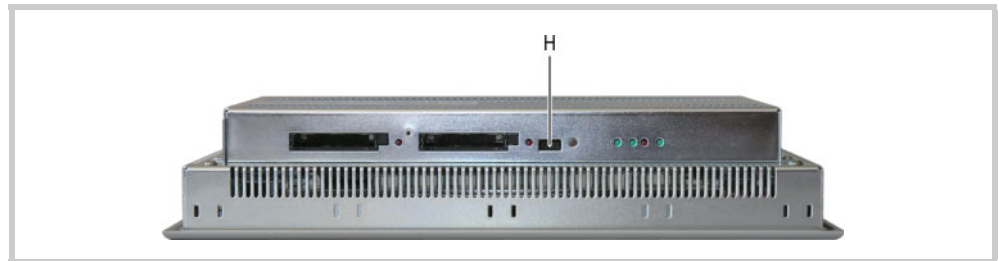

Fig. 8 Service side of the device

Interface	Interface description
A Power supply	→ Chapter 5.3.3, 29
B System Port	→ Chapter 5.3.4, 30
C Ethernet	→ Chapter 5.3.5, 32
D USB Device	→ Chapter 5.3.6, 33
E USB Host 0	→ Chapter 5.3.7, 33
F USB Host 1	→ Chapter 5.3.7, 33
G Profibus	→ Chapter 5.3.8, 34
H DIAG	Only for service tasks

Tab. 8 Overview of interfaces

5.3.2

Preparation of cables with D-Sub connector

The preparation of bus cables is an essential factor in ensuring reliable operation and electromagnetic compatibility (EMC).

Wiring requirements

- The cables must be shielded.
- The cable shield must be made from a copper braid.
- The cable shield must make a low impedance connection with the connector casing over a large contact area. This is achieved by:
 - Use of metal or metallized connector casings with a cable clamp for strain relief.
 - The cable clamp must be screwed securely to the connector.

Connecting the cable shield

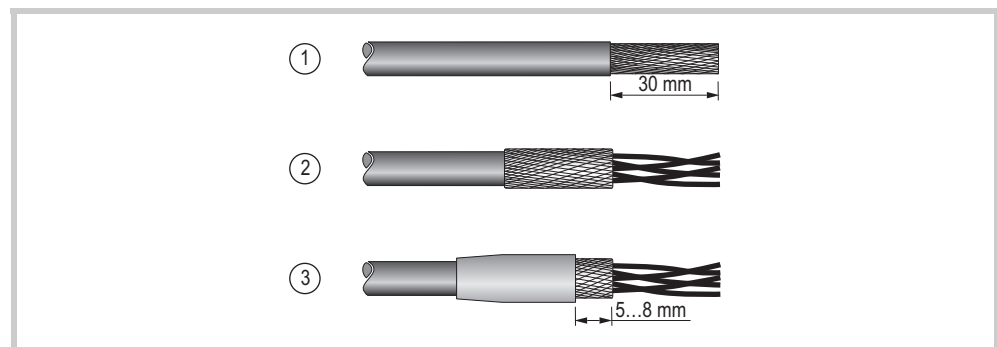

Fig. 9 Connecting the cable shield

- 1 Strip the cable end so that approx. 3 cm of the shield braid is exposed.
- 2 Fold back the shield braid over the cable shield.
- 3 Fit approx. 3 cm of heat shrinkable tubing over the folded back end of the shield braid or use a rubber grommet.
 - 5...8 mm of the shield braid must be exposed at the cable end.
 - The folded back shield braid end must be covered by the heat shrinkable tubing or by the rubber grommet.
- 4 Fit the D-Sub connector to the cable end:
 - The exposed metal shield braid must be clamped to the connector casing with the cable clamp.

5 Installation

5.3 Interfaces

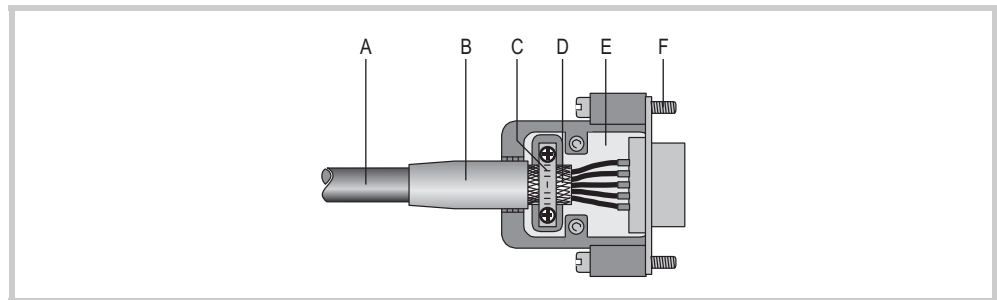



Fig. 10 Cable prepared with D-Sub connector

- | | |
|--|----------------------|
| A Cable with cable sheath | D Shield braid |
| B Heat shrinkable tubing or rubber grommet | E D-Sub connector |
| C Cable clamp | F Mounting screw UNC |

 **The EMC values stated in the technical data (immunity and emission) can only be guaranteed by observing the prescribed cable preparation!**

5.3.3

Power supply

The device is provided with an internal fuse and is protected against polarity reversal. The functional earthing terminal is connected to both the housing and the 0 V terminal. The device power supply is **not** electrically isolated.

The device requires a 24 VDC power supply from an AC/DC converter with safe isolation (SELV). For other power supply requirements see Chapter 9.5.1 Power supply, 60.

- SELV (safety extra low voltage):
Circuit in which no dangerous voltage is present, even in the event of a single fault.

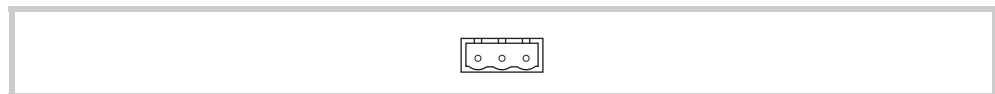

Fig. 11 Power supply interface

Wiring

- Phoenix Contact MSTB 2.5/3-ST-5.08 connector, Phoenix order no. 1757022 is supplied with the device.

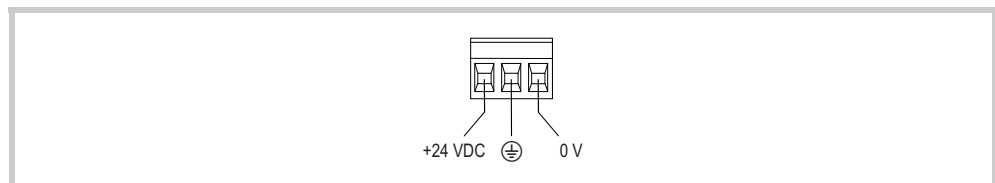

Fig. 12 Phoenix Contact MSTB 2.5/3-ST-5.08 connector (view from the wiring side)

Connection	Assignment
+24 VDC	+24 VDC power supply
⊕	Functional earthing connected to housing. Does not have to be connected. Exception: for UL approval (→ Chapter 5.2.1, 24). This connection can be used as protective earthing connection if the mounting environment requires this.
0 V	0 V power supply (connected to ⊕)

Tab. 9 Assignment of connector

- The following must be observed when the connector wiring is prepared:

Preparing the wiring of the connector

Terminal type	Pluggable screw terminal
Cross-section	<ul style="list-style-type: none"> ■ min. 0.75 mm² / max. 2.5 mm² (lead or wire) ■ min. AWG18 / max. AWG12
Stripping length	7 mm
Max. tightening torque	0.6...0.8 Nm / 5...7 Lb. In.

Tab. 10 Preparing the wiring of the connector

5 Installation

5.3 Interfaces

5.3.4

RS232 (System Port)

The RS232 interface is **not** electrically isolated. The GND pin is directly connected to the housing potential.

CAUTION



Non-isolated interfaces

The device may be damaged due to potential differences.

▶ The GND terminals of all bus stations must be connected.

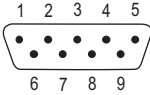

Fig. 13 RS232 interface (9-pin, D-Sub, male, UNC)

Pin	Signal	Assignment
1	DCD	Data Carrier Detected
2	RxD	Receive Data
3	TxD	Transmit Data
4	DTR	Data Terminal Ready
5	GND	Ground
6	DSR	Data Set Ready
7	RTS	Request to Send
8	CTS	Clear to Send
9	RI	Ring Indicator

Tab. 11 Pin assignment of the RS232 interface

Wiring

- Shielded cables must be used.
- The maximum baud rate depends on the cable length:

Cable length	Max. baud rate
2.5 m	115200 Bit/s
5 m	57600 Bit/s
10 m	38400 Bit/s
15 m	19200 Bit/s
30 m	9600 Bit/s

Tab. 12 Relationship of cable length / baud rate



When preparing the cables, ensure that there is a low-resistance connection between the cable shield and the connector casing (→ Chapter 5.3.2, 27).

5 Installation

5.3 Interfaces

5.3.5

Ethernet

For the approval in accordance with the standard UL 60950, consideration must be given to the conditions for use in an end-product (according to Underwriters Laboratories Inc. (UL)):

- In order to protect the device from potential internet threats, it should be connected to Ethernet networks that are isolated from the internet or safety protected and isolated from the Corporate/Enterprise network by a firewall or router.

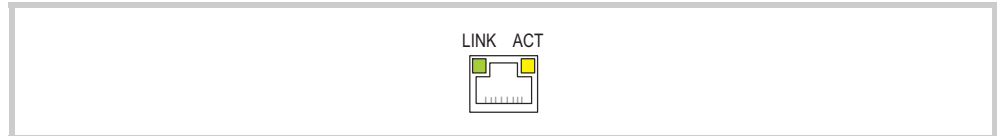

Fig. 14 Ethernet interface (RJ45 socket)

LED	Signal	Meaning
ACT (yellow)	flashes	Ethernet is active (data traffic)
LINK (green)	lit	Active network is connected and detected

Tab. 13 Control LEDs of the Ethernet interface

Cable

- Use shielded twisted pair cable (STP) for networking:
 - For device to device connection: crossover cable
 - For connecting to the hub/switch: 1:1 patch cable
- Maximum cable length: 100 m.

CAUTION



Forces acting on the Ethernet interface

Communication can be disturbed and the connection mechanics damaged if the Ethernet interface is exposed to severe vibration or the RJ45 plug connection is pulled.

- ▶ Protect the RJ45 connection from severe vibration.
- ▶ Protect the RJ45 connection from pulling on the socket.

5.3.6

USB Device

The USB Device interface supports USB 1.1.



Fig. 15 USB Device interface (USB Device, type B)

Cable

- Only use shielded USB standard cable.
- Maximum cable length: 5 m.

5.3.7

USB Host

The USB Host interfaces support USB 2.0.

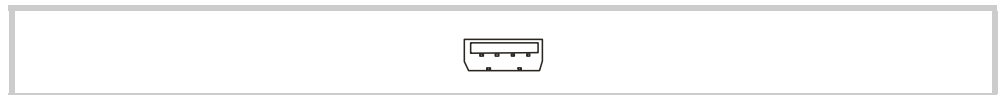

Fig. 16 USB Host interface (USB Host, type A)

Cable

- Only use shielded USB standard cable.
- Maximum cable length: 5 m.

5 Installation

5.3 Interfaces

5.3.8

Profibus

The Profibus interface is electrically isolated.

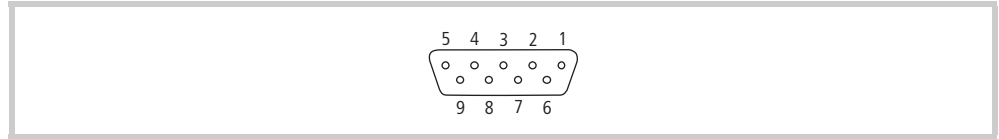

Fig. 17 Profibus interface (9-pin, D-Sub, female, UNC)

Pin	Signal	Assignment
1	-	nc
2	-	nc
3	B	EIA RS 485 line B
4	RTSAS	Output for controlling a repeater
5	M5EXT	0V output for external termination
6	P5EXT	5V output for external termination
7	-	nc
8	A	EIA RS 485 line A
9	-	nc

Tab. 14 Pin assignment of the Profibus interface



Pin 6 (5 V) must not be used as a power supply for external devices.

Wiring

- Shielded twisted pair cables, cable type A (in accordance with Profibus standards IEC/EN 61158 and IEC/EN 61784) must be used.

Cable specifications

Rated surge impedance	150 Ω
Permissible surge impedance	135... 165 Ω
Capacitance per unit length	< 30 pF/m
Loop resistance	< 110 Ω/km
Core cross-section	≥ 0.34 mm ² (22 AWG)

Tab. 15 Cable specifications

- The maximum baud rate depends on the cable length:

Cable length	Max. baud rate
200 m	1500 Kbit/s
400 m	500 Kbit/s
1000 m	187.5 Kbit/s
1200 m	≤ 93.75 Kbit/s

Tab. 16 Relationship of cable length / baud rate (for cables compliant with cable type A of the Profibus standard IEC/EN 61158 and IEC/EN 61784)

- ☞ **When preparing the cables, ensure that there is a low-resistance connection between the cable shield and the connector casing (→ Chapter 5.3.2, 27).**

Profibus topology

- A bus segment can connect up to 32 bus stations.
- Several bus segments can be linked via repeaters (bidirectional amplifiers). Refer to the documentation of the repeater manufacturer for further information.

- ☞ **The maximum cable length can be increased by using repeaters. Refer to the documentation of the repeater manufacturer for further information.**

- Only use bus terminal connectors that are specified for use in the Profibus network. They hold both bus cables on a bus station and ensure a low impedance connection of the cable shield to the shield reference potential of the bus station. These bus terminal connectors contain the Profibus cable termination that can be switched on as required.
- A bus segment must be provided with cable termination at both ends. The termination is passive and is fed from the bus station. It ensures a defined idle signal on the bus when no bus station is transmitting. These bus terminations should be implemented externally in the connector casing according to the Profibus standard (they can also be implemented with the bus terminating connector described above).

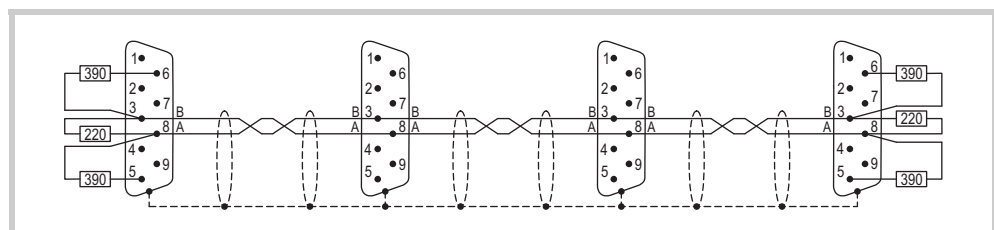

Fig. 18 Bus segment with four bus stations

- ☞ **■ The bus segment must be terminated at both ends.**
- No more than two terminations must be provided on each bus segment.
- At least one of the two terminations must be fed by the bus station.
- Transmission faults can occur if operation is carried out without the correct termination on the Profibus network.

5.4

Mounting

CAUTION



Operational malfunctions

Use of unsuitable or improperly prepared cables, as well as incorrect wiring will mean that neither the values stated in the technical data nor the electromagnetic compatibility (EMC) can be ensured.

- ▶ Only use cables prepared by specialists.
- ▶ The cables used must be prepared according to the interface description in this document.
- ▶ The wiring instructions for the relevant interface must be observed when wiring the device.
- ▶ Any generally applicable regulations and standards must be fulfilled.

CAUTION



Device condensation

If the device is or was exposed to climatic changes (temperature fluctuation, air humidity) moisture can form on or in the device (device condensation). In this case, there is a risk of short-circuit.

- ▶ The device must **not** be switched on when device condensation is present.
- ▶ If condensation is present on the device, or if it was exposed to temperature fluctuations, it must be allowed to adjust to room temperature (do not expose the device to the direct heat of heating devices) prior to commissioning.

1 Check the device for damage in transit.



The device must only be installed and commissioned in perfect technical condition and in compliance with this document.

2 Mount the device in the control cabinet, control panel or the control desk. See Chapter 5.4.1 Mounting the device, 37.

3 Connect the device as required.

- Follow the instructions on wiring the relevant interface. See Chapter 5.3 Interfaces, 25.



The device is not provided with an On/Off switch. If the power supply is not provided with a switch, the device will start up (boot) as soon as it is connected to the power supply.

5.4.1

Mounting the device

- An additional set of retaining brackets is required for mounting in accordance with IP65 and for use in potentially explosive atmospheres. Please contact your supplier.
- 10.4" and 12.1" devices can be mounted horizontally or vertically, 15" devices must only be mounted horizontally.

- 1 Select the mounting position of the device as described in Chapter 5.2.2 Requirements for the mounting position, 24.
- 2 Prepare a mounting cutout for the device at the selected position:
 - Mounting cutout:
 - 10.4" devices: 329×238 mm (± 1 mm)
 - 12.1" devices: 344×262 mm (± 1 mm)
 - 15" devices: 410×315 mm (± 1 mm)
 - Material thickness at the mounting cutout 2...5 mm

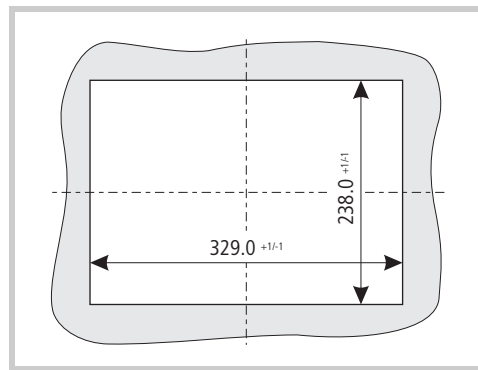

Fig. 19 Mounting cutout for 10.4" devices

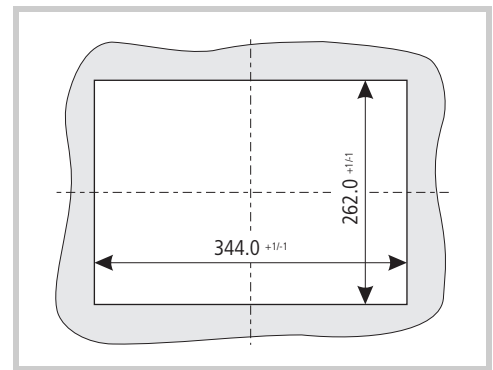

Fig. 20 Mounting cutout for 12.1" devices

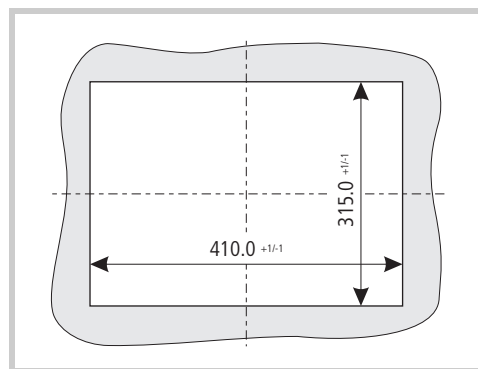



Fig. 21 Mounting cutout for 15" devices

5 Installation

5.4 Mounting

- 3 Insert the sealing strip supplied in the groove (A) on the rear of the device front plate and cut it so that the join is tight.

CAUTION	
	<p>Poor sealing</p> <p>Poor sealing resulting from the twisting of the sealing strip or due to a gap between the ends of the sealing strip.</p> <ul style="list-style-type: none">▶ The join of the sealing strip must be positioned on the bottom of the device.▶ Do not twist the sealing strip when it is inserted.▶ Cut the sealing strip to a suitable length so that the join is tight.

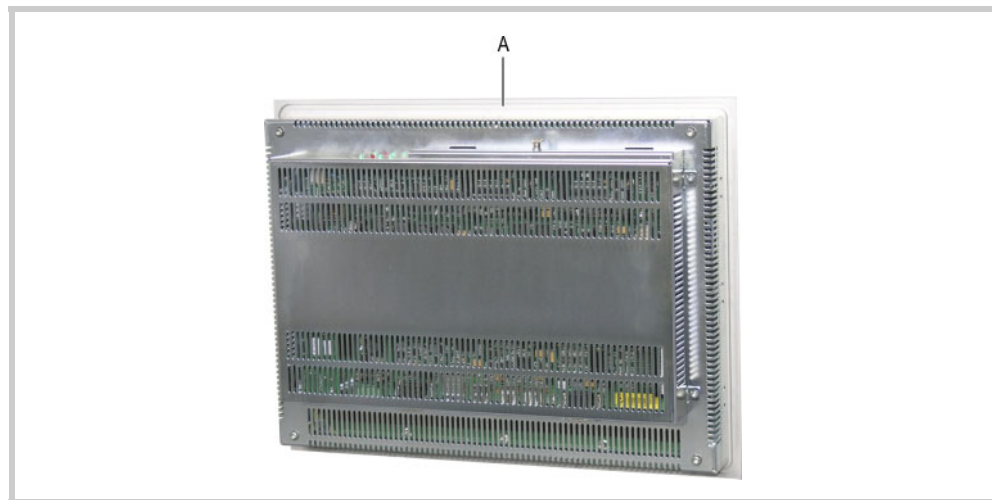

Fig. 22 Groove for sealing strip (A)

- 4 Fit the supplied threaded pins in the retaining brackets beforehand.

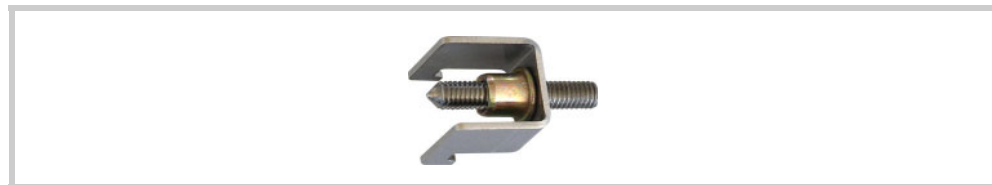



Fig. 23 Threaded pin pre-fitted in a retaining bracket

- 5 Fit the device from the front into the mounting cutout.

- Clip on the retaining brackets in the recesses provided for them on the device as shown below and fix the device by tightening the threaded pins until the front of the MICRO PANEL is flush with the surface of the control cabinet at the fixing points.

CAUTION	
	<p>Mechanical damage to the device</p> <p>Tightening the threaded pins too tightly may damage the device.</p> <p>▶ Tighten threaded pins with a max. tightening torque of 0.2 Nm.</p>

-  **The positions of the retaining brackets depend on:**
- the size of the device and
 - the mounting requirements.
- 10.4" and 12.1" devices (standard mounting):
- Top and bottom of the device:
Fit one retaining bracket each at the left and right fixing position

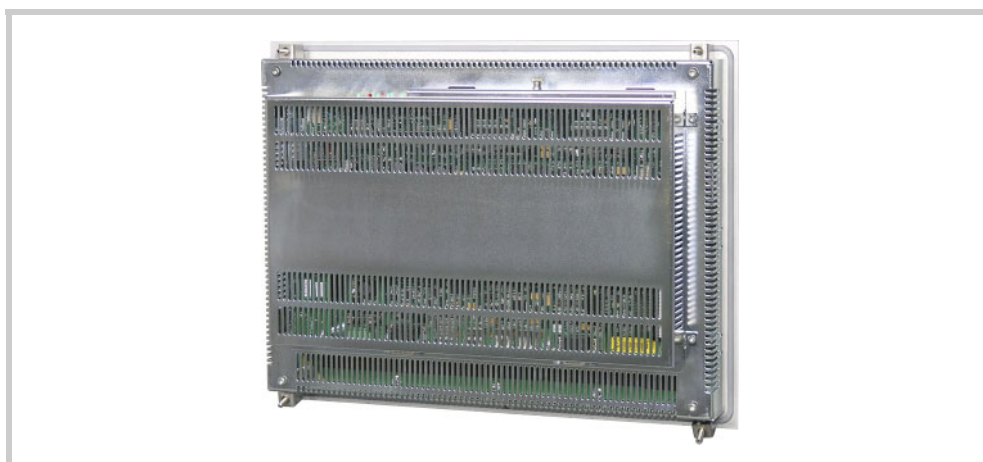

Fig. 24 10.4" and 12.1" devices with four retaining brackets (do not meet IP65 requirements)

5 Installation

5.4 Mounting

- 10.4" and 12.1" devices which must be mounted in accordance with IP65 or used in potentially explosive atmospheres:
 - Top and bottom of the device:
One retaining bracket at each of the fixing positions (left, right and in the center)
 - Left and right on the device:
One retaining bracket each at the central fixing position



Fig. 25 10.4" and 12.1" devices with eight retaining brackets (meet IP65 requirements)

- 15" devices (standard mounting):
 - Top and bottom of the device:
One retaining bracket each at the second fixing position from the left and from the right
 - Left and right on the device:
One retaining bracket each at the top and bottom fixing position



Fig. 26 15" devices with eight retaining brackets (do not meet IP65 requirements)

- 15" devices which must be mounted in accordance with IP65 or used in potentially explosive atmospheres:
 - Top and bottom of the device:
One retaining bracket each at the outermost and at the two innermost fixing positions
 - Left and right on the device:
One retaining bracket each at the two innermost fixing positions



Fig. 27 15" devices with twelve retaining brackets (meet IP65 requirements)

5 Installation
5.4 Mounting

6 Operation

6.1 Safety regulations

 Read Chapter 3 Safety regulations, 11 before working with the device. This contains important information for your personal safety.

CAUTION



Sensitive resistive touch surface

Damage to the resistive touch due to the use of pointed or sharp objects.

- ▶ Only activate the resistive touch with your finger or a stylus.
- ▶ When wearing gloves, ensure that these are clean. They must not be covered with abrasive dust or sharp particles.

CAUTION



Device condensation

If the device is or was exposed to climatic changes (temperature fluctuation, air humidity) moisture can form on or in the device (device condensation). In this case, there is a risk of short-circuit.

- ▶ The device must **not** be switched on when device condensation is present.
- ▶ If condensation is present on the device, or if it was exposed to temperature fluctuations, it must be allowed to adjust to room temperature (do not expose the device to the direct heat of heating devices) prior to commissioning.

6.2

Starting the device

- 1 Insert the CF card with the operating system:

CAUTION



Data loss

During a write operation, the CF card may lose data or may be destroyed if it is removed or if there is a power failure.

- ▶ Always secure CF cards with the CF slot cover.
- ▶ Avoid write operations to CF cards. Reasons:
 - The number of write cycles possible on CF cards is limited.
 - A power failure during write operations will most likely lead to loss of data.
- ▶ Before removing the CF card in CF slot 1, ensure that no software write operations to the CF card are in progress («CF ACT» LED must not be lit).
- ▶ Only remove the CF card from CF slot 0 when the device is in a de-energized state.
- ▶ Before switching off, ensure that no software write operations to the CF card are in progress («CF ACT» LED must not be lit).

- 1.1 Remove the CF slot cover (A).

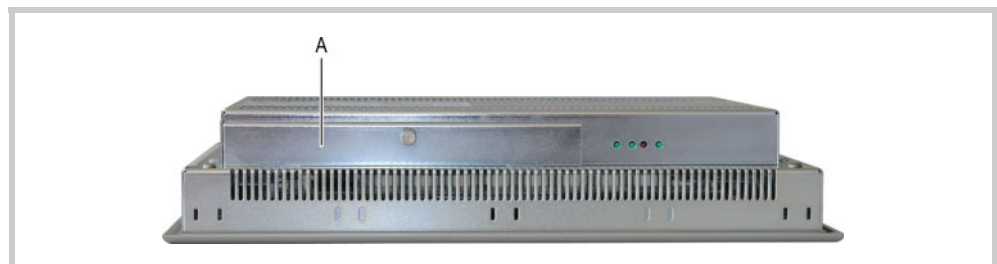



Fig. 28 Service side of the device (CF slot cover fitted)

- 1.2 Insert the CF cards into the CF slots:
 - CF card with operating system in CF slot 0 (C)
 - CF card with data in CF slot 1 (B)

 **Do not apply any force (CF cards are protected against reverse insertion).**

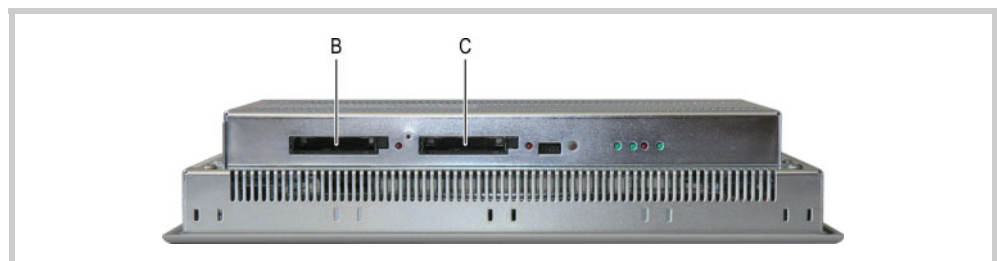



Fig. 29 Service side of the device (CF slot cover removed)

- 1.3 Fit the CF slot cover (A).

- 2 Energize the device.
 - The device will boot.
- 3 If the device does not boot up and/or if an error message appears while starting (booting) the device, see Chapter 7.4 Troubleshooting,  51.
- 4 Complete the following steps after initial commissioning (→ Document «MN05010007Z-EN System Description Windows CE»):
 - 4.1 Adjust the system settings of the device.
 - 4.2 Install the required application programs.



The lifespan of the backlight can be increased by reducing the brightness (→ Document «MN05010007Z-EN System Description Windows CE»).

6 Operation

6.3 Switching off the device

6.3

Switching off the device

CAUTION	
	<p>Data loss</p> <p>During a write operation, the CF card may lose data or may be destroyed if it is removed or if there is a power failure.</p> <ul style="list-style-type: none">▶ Always secure CF cards with the CF slot cover.▶ Avoid write operations to CF cards. Reasons:<ul style="list-style-type: none">- The number of write cycles possible on CF cards is limited.- A power failure during write operations will most likely lead to loss of data.▶ Before removing the CF card in CF slot 1, ensure that no software write operations to the CF card are in progress («CF ACT» LED must not be lit).▶ Only remove the CF card from CF slot 0 when the device is in a de-energized state.▶ Before switching off, ensure that no software write operations to the CF card are in progress («CF ACT» LED must not be lit).

 **Frequent on/off switching of the device, especially at low temperatures, will reduce the lifespan of the cold cathode tubes (CCFL) of the backlight.**

- **Avoid frequent on/off switching of the device.**
- **Reduce the brightness of the backlight instead (→ Document «MN05010007Z-EN System Description Windows CE»).**

1 De-energize the device.

7 Maintenance and service

7.1 Safety regulations



Read Chapter 3 Safety regulations, 11 before working with the device. This contains important information for your personal safety.

7 Maintenance and service

7.2 Maintenance

7.2

Maintenance

Devices with resistive touch are maintenance-free. However, the following work may be necessary:

- Cleaning of the resistive touch if contaminated.
- Recalibration of the resistive touch if it does not respond correctly to touch operation.

The infra-red frame on devices with infra-red touch must be cleaned regularly (see Chapter 7.2.3 Cleaning the infra-red touch, 49). Otherwise these devices are maintenance-free.

7.2.1

Cleaning the resistive touch

CAUTION	
	<p>Cleaning the device</p> <p>Damage to the device due to the use of pointed or sharp objects or by liquids.</p> <ul style="list-style-type: none">▶ Do not use any pointed or sharp objects (e.g. knife) for cleaning.▶ Do not use any aggressive or abrasive cleaning agent or solvent.▶ Avoid any liquid entering the device (risk of short-circuit).

- 1 Clean the resistive touch carefully with a clean, soft, damp cloth.
 - With stubborn contamination, spray a little cleaning agent onto the damp cloth first.

7.2.2

Recalibrating a resistive touch

The resistive touch is already calibrated when delivered. However, it must be recalibrated if it does not respond correctly to touch operation. Touch calibration, see Document «MN05010007Z-EN System Description Windows CE».



7.2.3

Cleaning the infra-red touch

The infra-red frame must be cleaned regularly.



The infra-red touch needs to be cleaned if the following is indicated:

- On the service side, the «TOUCH ERROR» LED flashes
- On the taskbar of the display, one of the following icons will appear:
 -  : Contaminated touch sensor
 -  : Faulty or severely contaminated touch sensor
- A visualization application will show an appropriate warning.

The infra-red channels may be interrupted if the infra-red frame is severely contaminated. In extreme cases, this may mean that the affected zones of the touch sensor cannot be touch activated.

CAUTION	
	<p>Cleaning the device</p> <p>Damage to the device due to the use of pointed or sharp objects or by liquids.</p> <ul style="list-style-type: none">▶ Do not use any pointed or sharp objects (e.g. knife) for cleaning.▶ Do not use any aggressive or abrasive cleaning agent or solvent.▶ Avoid any liquid entering the device (risk of short-circuit).

- 1 Clean the infra-red frame and the display with a clean, soft, damp cloth.
 - With stubborn contamination, spray a little cleaning agent onto the damp cloth first.

7.2.4

Recalibrating the infra-red touch

Devices with infra-red touch do not have to be recalibrated.

7.2.5

Battery

The integrated battery cannot be exchanged. Lifespan, see Chapter 9.4 System, 59.

7 Maintenance and service

7.3 Service

7.3 Service

7.3.1 Repairs

The device must only be opened by the manufacturer or by an authorized repair center.

Contact your local supplier or Eaton technical support for repairs.

Only the original packaging should be used for transporting the device.



7.4

Troubleshooting

Fault and possible cause	Corrective action
Device does not start (boot).	
Power supply interface does not have any power.	Check the power supply cable.
While the device is starting (booting), the following message appears:	
«No Card in CF slot 0 detected !!!»	
The CF slot 0 does not contain a CF card.	Insert the CF card with the operating system in the CF slot 0.
CF card in CF slot 0 could not be read (faulty).	Replace CF card.
«Search Subdirectory ... not found»	
The CF card in CF slot 0 does not have an OS (operating system).	<ul style="list-style-type: none"> ■ If the CF card does not contain an operating system, load one onto a CF card. ■ Insert the CF card with the operating system in the CF slot 0.
«<50> Touch is dirty or defect» (only appears if GALILEO is installed)	
Resistive touch is not correctly calibrated.	<ul style="list-style-type: none"> ■ Start (boot) the device. ■ Calibrate touch (→ Document «MN05010007Z-EN System Description Windows CE»).
Infra-red frame of the infra-red touch is contaminated.	Clean the infra-red frame (→ Chapter 7.2.3, 49).
The threaded pins for mounting the device have been tightened too much.	Loosen the threaded pins (observe max. torque, → Chapter 5.4.1, 37).
Device is faulty.	Send in your device for repair.
Display remains or becomes dark.	
Backlight is switched off.	Check the function in the visualization software.
Backlight is faulty.	Send in your device for repair.
Touch does not react or does not react correctly to touch operation.	
Resistive touch is not correctly calibrated.	<ul style="list-style-type: none"> ■ Start (boot) the device. ■ Calibrate touch (→ Document «MN05010007Z-EN System Description Windows CE»).
Infra-red frame of the infra-red touch is contaminated.	Clean the infra-red frame (→ Chapter 7.2.3, 49).

7 Maintenance and service

7.4 Troubleshooting

Fault and possible cause	Corrective action
Touch is deactivated.	<ul style="list-style-type: none">■ Start (boot) the device.■ Activate touch (→ Document «MN05010007Z-EN System Description Windows CE»).
LED «TOUCH ERROR» permanently lit and/or the icon  appears in the taskbar.	
Incorrect operation of the operating elements on the display.	Remove all objects from the area of the display.
Infra-red frame of the infra-red touch is contaminated.	Clean the infra-red frame (→ Chapter 7.2.3,  49).
The threaded pins for mounting the device have been tightened too much.	Loosen the threaded pins (observe max. torque, → Chapter 5.4.1,  37).
Device is faulty.	Send in your device for repair.

Tab. 17 Troubleshooting

8 Storage, transport and disposal

8.1 Safety regulations



Read Chapter 3 Safety regulations, 11 before installing and commissioning the device. This contains important information for your personal safety.

8.2 Storage

The ambient conditions for storage must be fulfilled. See Chapter 9.9 Ambient conditions, 63.

8.3 Transport

Damage to the device must be prevented during transport (use an appropriate packaging).

The ambient conditions must be fulfilled even when the device is transported. See Chapter 9.9 Ambient conditions, 63.



- 1 Check the device on arrival for damage in transit.

8 Storage, transport and disposal

8.4 Disposal

8.4

Disposal

 DANGER	
	<p>Explosive and toxic materials</p> <p>Any improper handling causes a risk of explosion due to the lithium battery soldered in the device and a risk of poisoning due to the mercury content of the cold cathode tubes.</p> <p>▶ Dispose of the device properly.</p>

Devices that are no longer used must be properly disposed of in accordance with the applicable national regulations or returned to the manufacturer or sales office.

Materials used in the device

Component	Material
Housing	Galvanized sheet steel
Front plate	Aluminum, Peraluman 101 anodized
Infra-red frame	Polycarbonate (PC)
Infra-red touch protective panel	Glass
Resistive touch back panel	Glass with polyester foil
Cold cathode tubes	Mercury (< 5 mg)
Battery	Lithium
Electronic components	Various

Tab. 18 Materials used in the device



The materials used for our housings are halogen-free.

Materials used in the packaging

Packaging	Material
External packaging	Cardboard
Internal packaging:	
10.4" and 12.1" devices	<ul style="list-style-type: none">■ Cardboard with PE foil■ Plastic bag: Polyethylene (PE)
15" devices	<ul style="list-style-type: none">■ Closed-cell polyethylene foam, CFC-free■ Plastic bag: Polyethylene (PE)

Tab. 19 Materials used in the packaging

9 Technical data

9.1 Dimensions and weights

9.1.1 10.4" devices

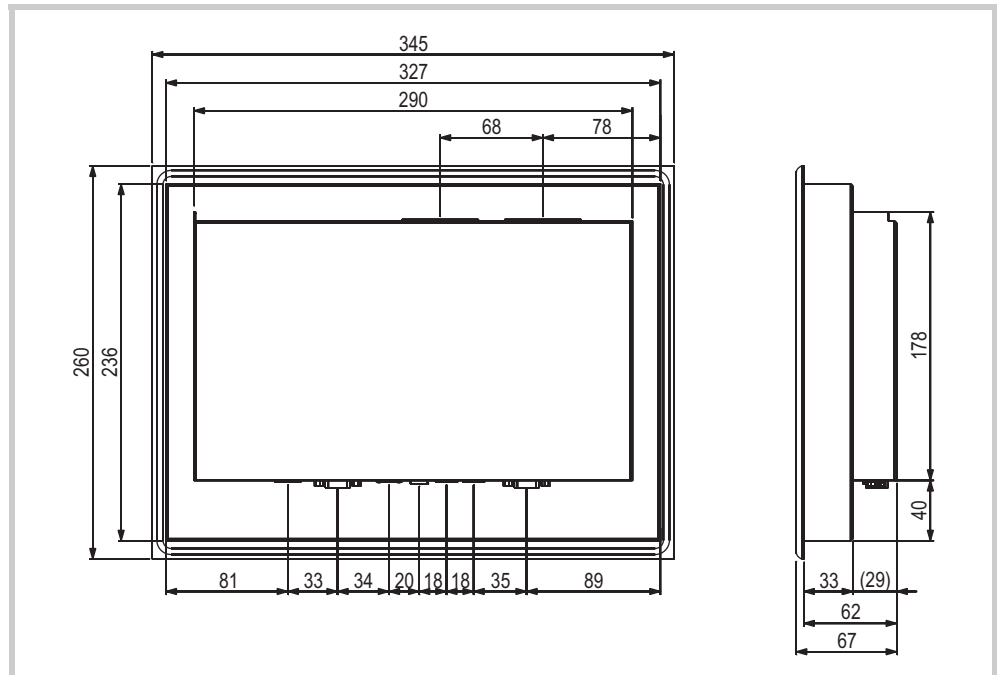

Fig. 30 Mechanical dimensions of the 10.4" devices in mm

Property	XVS400 10.4"; MS2 10.4"
Height	260 mm
Width	345 mm
Depth	67 mm
Thickness of front plate	5 mm
Mounting depth	62 mm
Mounting cutout	329 × 238 mm (±1 mm)
Weight	Approx. 3.7 kg

Tab. 20 Dimensions and weights of the 10.4" devices

9 Technical data

9.1 Dimensions and weights

9.1.2

12.1" devices

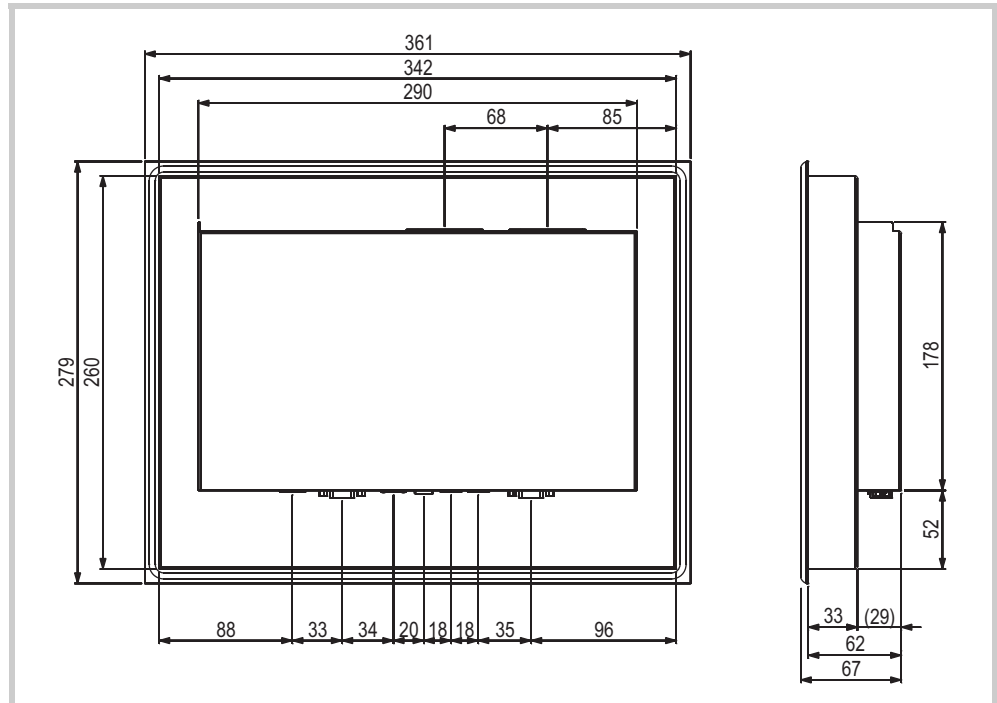

Fig. 31 Mechanical dimensions of the 12.1" devices in mm

Property	XVS400 12.1"; MS2 12.1"
Height	279 mm
Width	361 mm
Depth	67 mm
Thickness of front plate	5 mm
Mounting depth	62 mm
Mounting cutout	344 × 262 mm (±1 mm)
Weight	Approx. 4.1 kg

Tab. 21 Dimensions and weights of the 12.1" devices

9.2

Display

Property	XVS400 10.4"/12.1"/15"; MS2 10.4"/12.1"
Type	TFT-LCD (color)
Resolution (W × H)	
10.4" devices	VGA (640 × 480 pixels)
12.1" devices	SVGA (800 × 600 pixels)
15" devices	XGA (1024 × 768 pixels)
Visible display area	
10.4" devices	211 mm × 158 mm (10.4" screen diagonal)
12.1" devices	246 mm × 185 mm (12.1" screen diagonal)
15" devices	304 mm × 228 mm (15" screen diagonal)
Color resolution	Adjustable: 65536 or 256 colors
Contrast ratio	Normally 350:1
Brightness	
10.4" and 12.1" devices	Normally 350 cd/m ²
15" devices	Normally 400 cd/m ²
Backlight	
Technology	
10.4" and 12.1" devices	2× CCFL
15" devices	4× CCFL
Dimmable via software	100 %, 80 %, 60 %, 40 % brightness
Lifespan	Normally 50 000 h
Resistive touch back panel	Touch sensor (absolutely flat, seamless)
Infra-red touch protective panel	Non-reflective safety glass

Tab. 23 Display

9.3 Touch sensor

9.3.1 Devices with resistive touch

Property	XVS400 10.4"/12.1"; MS2 10.4"/12.1"
Type	Resistive touch
Technology	4-wire

Tab. 24 Touch sensor of the devices with resistive touch

9.3.2 Devices with infra-red touch

Property	XVS400 10.4"/12.1"/15"; MS2 10.4"/12.1"
Type	Infra-red touch
Resolution	
10.4" devices	79 × 59 logic channels
12.1" devices	95 × 71 logic channels
15" devices	107 × 83 logic channels

Tab. 25 Touch sensor of the devices with infra-red touch

9.4 System

Property	XVS400 10.4"/12.1"/15"; MS2 10.4"/12.1"
Processor	RISC, 32-bit, 400 MHz
Internal memory	
DRAM	64 MByte
FLASH	Approx. 1.5 MByte available
NVRAM	Approx. 32 KByte available
External memory	
CF slot	2× CompactFlash Card Type I/II for operating system, programs and data Use only original accessories.
Real-time clock (battery backup)	
Battery type	CR2032 (190 mA/h), maintenance-free (soldered)
Backup time in de-energized state	Normally 10 years

Tab. 26 System

9.5

Interfaces

Property	XVS400 10.4"/12.1"/15"; MS2 10.4"/12.1"
Ethernet	100Base-TX / 10Base-T
System Port	RS232, not electrically isolated
USB Host	2 × USB 2.0 (1.5 / 12 Mbit/s), not electrically isolated
USB Device	USB 1.1, not electrically isolated
Profibus	Profibus, electrically isolated, max. 1.5 Mbit/s
Power supply	→ Chapter 9.5.1, 60
DIAG	Only for service tasks

Tab. 27 Interfaces

9.5.1

Power supply

Property	XVS400 10.4"/12.1"/15"; MS2 10.4"/12.1"
Rated voltage	24 VDC SELV (safety extra low voltage)
Permissible voltage	<ul style="list-style-type: none"> ■ RMS value: 20.4 ... 28.8 VDC (rated voltage -15 % / +20 %) ■ Absolute with ripple: 19.2 ... 30.0 VDC ■ 35 VDC for a period < 100 ms
Voltage dips	<ul style="list-style-type: none"> ■ 10 ms from rated voltage (24 VDC) ■ 5 ms from undervoltage (20.4 VDC)
Power consumption	
10.4" and 12.1" devices	
Basic device	Max. 18 W (normally 14 W)
USB stations on USB host	2 × max. 3 W
Total	Max. 24 W
15" devices	
Basic device	Max. 30 W (normally 28 W)
USB stations on USB host	2 × max. 3 W
Total	Max. 36 W

Property	XVS400 10.4"/12.1"/15"; MS2 10.4"/12.1"
Current consumption	
Continuous current	
10.4" and 12.1" devices	Max. 1.0 A (24 VDC)
15" devices	Max. 1.5 A (24 VDC)
Starting current inrush	2.5 A ² s
Protection against reverse polarity	Yes
Fuse	Yes (replacement only by the manufacturer or by an authorized repair center)
Potential isolation	No

Tab. 28 Power supply

9.6

Enclosure ratings

Property	XVS400 10.4"/12.1"/15"; MS2 10.4"/12.1"
Front	IP65: Required accessories for mounting: ■ Additional set of retaining brackets (optional)
Rear	IP20

Tab. 29 Enclosure ratings

9.7

Agency approvals and standards

Property	XVS400 10.4"/12.1"/15"; MS2 10.4"/12.1"
EMC	2004/108/EC
Explosion protection	II 3D Ex tc IIIC T70°C IP6x (ATEX 94/9/EC): ■ Zone 22, category 3D ¹⁾ : Required accessories for mounting: - Additional set of retaining brackets (optional)
UL	UL 60950, file no. E208621

Tab. 30 Agency approvals and standards

- 1) Zone 22, category 3D:
- IP5x for devices of the group IIIB (non-conductive dust)
- IP6x for devices of the group IIIC (conductive dust)

9 Technical data

9.8 Applicable standards and regulations

9.8

Applicable standards and regulations

Property	XVS400 10.4"/12.1"/15"; MS2 10.4"/12.1"
EMC (in relation to CE)	
IEC/EN 61000-6-2	Immunity for industrial areas
IEC/EN 61000-6-4	Emission for industrial environments
IEC/EN 61131-2	Programmable logic controllers, equipment requirements and tests
Explosion protection (in relation to CE)	
ATEX 94/9/EC: Zone 22, Category 3D (II 3D Ex tc IIIC T70°C IP6x):	
IEC/EN 60079-0	Explosive atmospheres: equipment - general requirements
IEC/EN 61241-0 IEC/EN 61241-1	Electrical apparatus for use in the presence of combustible dust
Safety	
IEC/EN 60950 UL 60950	Safety of information technology equipment (Engineering conditions of acceptability by UL, → Chapter 5.2.1, 24)
Product standards	
EN 50178	Electronic equipment for use in power installations
IEC/EN 61131-2	Programmable logic controllers, equipment requirements and tests

Tab. 31 Applicable standards and regulations

9.9

Ambient conditions

Property	XVS400 10.4"/12.1"/15"; MS2 10.4"/12.1"
Temperature	
Operation	0 ... 50°C
Storage / Transport	-20 ... 60°C
Relative air humidity	10 ... 95%, non-condensing
Vibration in accordance with IEC/EN 60068-2-6	Displacement: <ul style="list-style-type: none"> ■ 5... 9 Hz: 3.5 mm ■ 9... 60 Hz: 0.15 mm Acceleration: <ul style="list-style-type: none"> ■ 60... 150 Hz: 2 g
Schock in accordance with IEC/EN 60068-2-27	15 g / 11 ms
Fall test	In accordance with IEC/EN 60068-2-31

Tab. 32 Ambient conditions

9 Technical data
9.9 Ambient conditions